

The ST chain hoist



09.2017

Partner of Experts

STAHL
CraneSystems ®

The ST chain hoist

The ST chain hoist programme ranks among the world's most distinctive and extensive ranges on offer. Users, crane manufacturers and systems manufacturers appreciate the robust classic which proves itself in operation day for day. It is powerful, reliable and undemanding as regards maintenance and power consumption. The supervised series production of the standard components brings you economic advantages. And in conjunction with the precise manufacture of off-standard components, the ST chain hoist is an acknowledged top level quality product.

The modular system permits numerous combinations of the sub-assemblies to achieve your individual solutions. The ST series from STAHL CraneSystems is available in 6 load capacity variants for the load capacity range from 125 kg to 6,300 kg. The chain hoists can be used as stationary models with suspension hook or eye, with rigid suspension or with a push trolley. Or when completed by an electric trolley they are mounted on standard cranes, off-standard cranes or in systems manufacture. The technical highlight that makes the patented ST chain hoist one of the safest around is its direct suspension from the solid cast iron chain guide. The load is supported at the point where it engages. Various off-standard designs are available for use in particular conditions. Two constructions optimise the effective hook height of all chain hoist models if required. The headroom of the short headroom trolley and extra short headroom trolley is reduced by 33 %

and over 60 % respectively. For exceptional requirements, our experts in the engineering department will develop suitable customised solutions. Even in explosive atmospheres you do not have to manage without the ST chain hoist. On request, nearly the entire chain hoist programme is available in explosion-protected design for Zone 1, Zone 21 and Zone 22.

It is no coincidence that we are one of the market leader for explosion-protected lifting technology and crane components.



Standard ST chain hoist with electric trolley



The facts

- Extensive chain hoist range for lifting capacities from 125 kg to 6,300 kg
- Suspension directly from the chain guide of solid cast iron
- Easy inspection and maintenance of the chain drive thanks to over-mounted drive shaft
- Extremely short and compact construction ensures that space can be utilised to the maximum
- High standard classification in accordance with ISO
- Modern Kanban production, available fast
- Available as an option in explosion-protected design complying with ATEX and IECEx

The models and trolley variants

Different construction types and trolley variants for the ST chain hoist open up the most varied applications in crane and systems manufacture. Individually tailored to your specific requirements as stationary hoist or for use with a trolley. The trolleys are equipped as standard with one travel speed, as an option the motors can be supplied with two travel speeds. But in this matter too we are open to your requirements. Our chain hoists are known worldwide for their flexible and versatile use. Compact dimensions and extremely short approach dimensions help to make optimum use of the production shop.

Suspension for stationary version

The standard stationary ST chain hoist has hook suspension. However you can also choose eye suspension or rigid suspension. The eye suspension is used when the stationary chain hoist is only rarely moved to a different location, while the low headroom permits long hook paths even in low-ceilinged rooms. If the ST chain hoist is to be permanently mounted, for example in systems manufacture, we recommend rigid suspension. Here too the extremely short headroom is of advantage. In addition, the rigid mounting prevents the chain hoist swinging on the trolley.

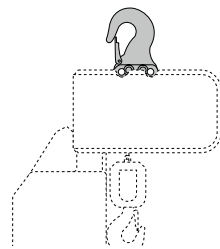

Hook

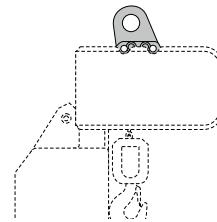

Eye

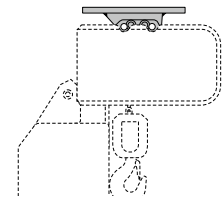

Rigid suspension

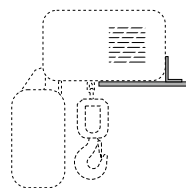

ST05 mounting

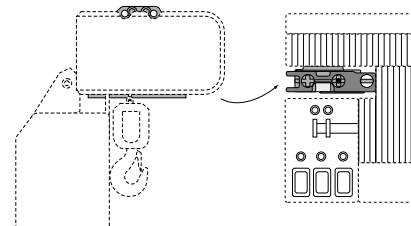

ST10 – ST60 mounting

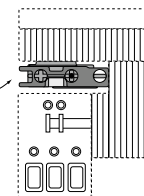

(view from below)

Foot mounting for stationary version

In order to utilise space optimally in low-ceilinged rooms the ST chain hoist can be bolted from below onto a foot mounting.

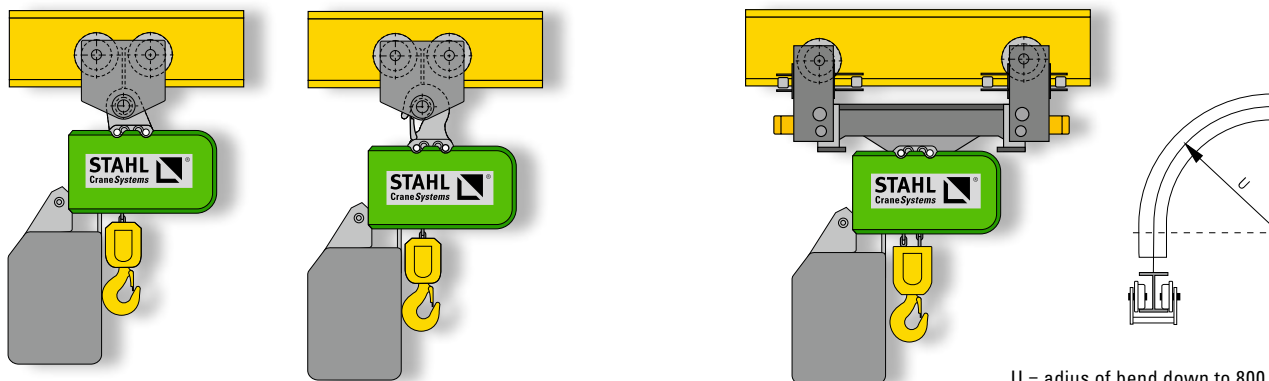

U = radius of bend down to 800 mm possible

Push trolley

In standard version, the ST05 and ST10 1/1 chain hoists are suspended by eye or hook from the smooth-running push trolleys. A rigid connection with the chain hoist is possible on request. This rigid connection is standard in the ST20 to ST60 chain hoists. The push trolley does not affect the low headroom of the hoist. Optional wheel arresters make your workplace safer.

Articulated trolley

The articulated trolley is available for frequent travel around bends and narrow radii. Depending on radius of bend, runway flange width or application it is equipped with one or two travel motors. The lateral guide rollers cause minimum wear. The articulated trolley is designed for load capacities up to 6,300 kg.

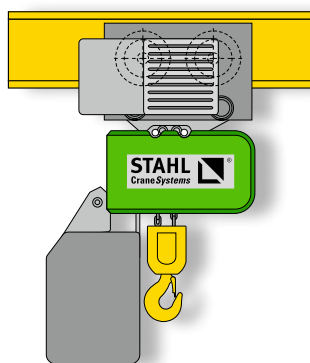

Standard headroom electric trolley

Not one millimetre was given away in the design in order to enable large hook paths even at standard headroom.

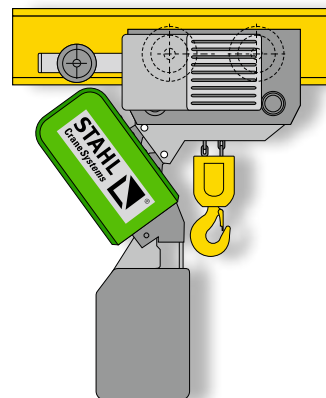

Short headroom electric trolley

The smooth-running electric trolley can also be combined with the ST short headroom chain hoist, reducing the headroom by a further 33%.

■ Standard
□ Option

Type	Load capacity up to [kg]	Stationary	Push trolley	Electric trolley	Articulated trolley	Short headroom trolley	Extra short headroom trolley	Dual chain hoist	Big Bag
ST 05	125 – 630	■	■	■	■	■	■	■	–
ST 10	500 – 1,000	■	■	■	■	■	–	■	■
ST 20	1,000 – 2,000	■	■	■	■	■	–	–	–
ST 30	1,250 – 3,200	■	■	■	■	■	■	■	■
ST 50	2,500 – 5,000	■	■*	■	■	■	■	■	■
ST 60	3,200 – 6,300	■	■*	■	■	■	□	■	–

* Only available with 1/1 reeving in the standard range.

The STK extra short headroom trolley

If you do not want to lose even a millimetre of lifting height, the STK extra short headroom trolley from STAHL CraneSystems is just the thing for you.

The construction of the short headroom trolley itself saves a tremendous amount of space. The body of the chain hoist is mounted at an angle, meaning that no return sheave is required. This reduces the headroom by 33 %. The extra short headroom trolley with its headroom reduced by 60 %, by contrast, achieves maximum hook paths, which is particularly beneficial in extremely low-ceilinged rooms. It fully deserves its name.

The extremely short distance from the underside of the beam to the bed of the hook is just 210 mm at a load capacity of 5,000 kg and even just 185 mm at a load capacity of 3,200 kg. The chain hoists used here, mounted vertically, are based on the standard ST chain hoist programme from STAHL CraneSystems.

The innovative patented chain guide is unique. Two separate chains running in synch act on a single bottom hook block. The load is lifted and positioned without swinging or vibrating.

The facts

- Very compact dimensions for maximum use of halls
- Specially developed for low-ceilinged rooms
- Low deadweight
- Load is lifted steadily and without swinging
- Low maintenance
- Trolleys with no projecting edges for steady cross travel
- Available as an option in explosion-protected design complying with ATEX and IECEx



The patented design of the extra short headroom trolley reduces its headroom by 60 % and permits exceptional lifting heights.

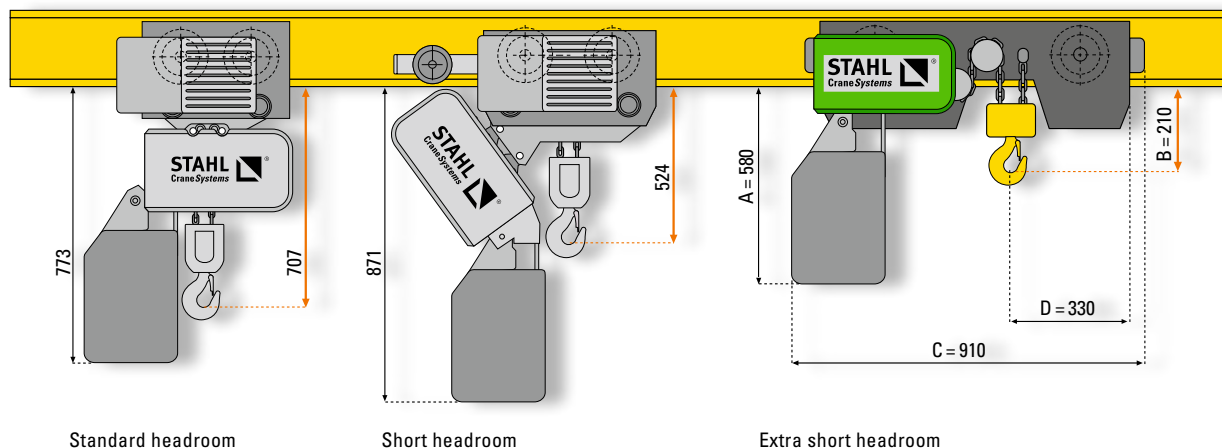

The dimensions apply to an ST chain hoist with a load capacity of 5,000 kg and standard lifting height of 3 m.

Type	STK 0502-8/2 2/2-1	STK 0502-8/2 4/2-1	STK 3016-8/2 2/2-1	STK 5025-8/2 2/2-1	STK 3016-8/2 4/2-1	STK 5025-8/2 4/2-1
Load capacity	500 kg	1,000 kg	1,600 kg	2,500 kg	3,200 kg	5,000 kg
Hoisting speed (50 Hz)	8 m/2 min	4 m/1 min	8 m/2 min	8 m/2 min	4 m/1 min	4 m/1 min
Hoisting speed (60 Hz)	10 m/2.5 min	5 m/1.2 min	10 m/2.5 min	10 m/2.5 min	5 m/1.2 min	5 m/1.2 min
No. of falls	2	4	2	2	4	4
Output (50 Hz)	0.8/0.2 kW	0.8/0.2 kW	2.3/0.57 kW	3.8/0.9 kW	2.3/0.57 kW	3.8/0.9 kW
Output (60 Hz)	0.96/0.24 kW	0.96/0.24 kW	2.8/0.68 kW	4.6/1.1 kW	2.8/0.68 kW	4.6/1.1 kW
Dimensions	Dimensions stated are approximate (subject to alterations)					
A	260 mm	490 mm	520 mm	580 mm	520 mm	580 mm
B	136 mm	151 mm	185 mm	210 mm	185 mm	210 mm
C	565 mm	750 mm	800 mm	910 mm	800 mm	910 mm
D	264 mm	290 mm	300 mm	330 mm	300 mm	330 mm

Other hoisting speeds, supplementary equipment such as gear limit switch and explosion-protected designs are possible. Please enquire.

The STD dual chain hoist

The STD dual chain hoist is an off-standard development for long goods and loads which need to be picked up at two points. It has two load chains which are driven in synch by a single hoist motor. The distance between the hooks can be selected to suit the goods to be transported. The design means that the two running hooks running in synch lift and transport the load without dangerous tilting. Its low headroom makes the STD dual chain hoist suitable for low-ceilinged rooms too and achieves maximum hook paths.

There are different versions of the STD dual chain hoist available. Depending on the requirements or the space available there are versions where the load hooks are either to both right and left or only on one side of the chain hoist. For stationary use, the STD chain hoist, adapted to the width of the load, is rigidly mounted on a substructure. In combination with an electric trolley the STD chain hoist becomes mobile. The STD Vario dual chain hoist with its electrically adjustable distance between hooks allows goods of different lengths to be lifted without difficulty, transported, and accurately positioned. Even when the loads have different lengths or the load hooks are differently loaded, the two load hooks run steadily and completely in synch.

The facts

- Low space requirement permitting maximum height of lift
- Two hook lead-offs running in synch on one hoist
- Synchronous lifting even with uneven loading, no tilting of the load
- Individually adapted to width of load
- Low maintenance
- Optionally available in explosion-protected design complying with ATEX and IECEx



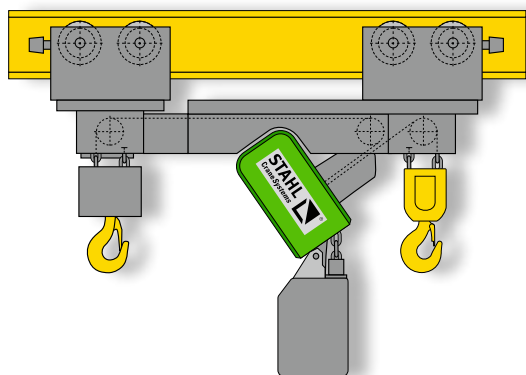

>Z< design

The load hooks are on the left and right of the chain hoist.

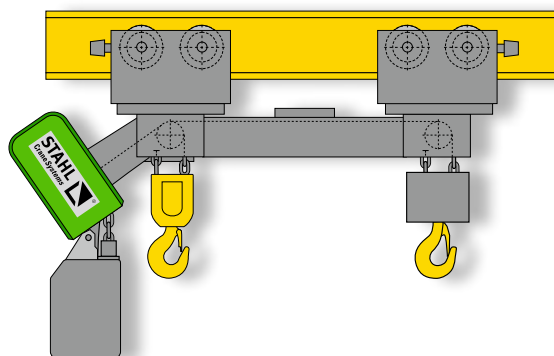

>E< design

The load hooks are on one side of the chain hoist.

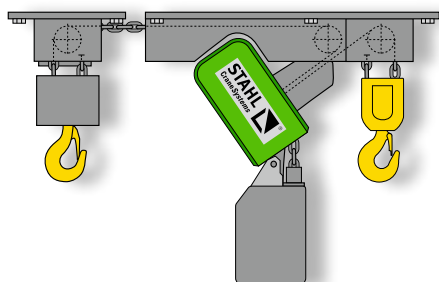

Stationary dual chain hoist >Z<

The STD chain hoist is adapted to the width of the load and rigidly mounted on a substructure. The load hooks are on the left and right of the chain hoist.

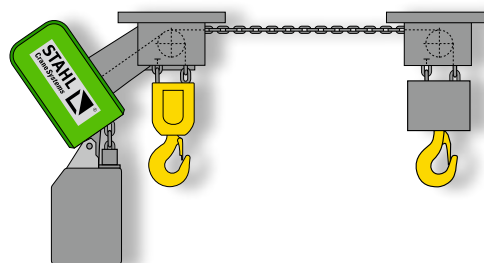

Stationary dual chain hoist >E<

The STD chain hoist is adapted to the width of the load and rigidly mounted on a substructure. The load hooks are on one side of the chain hoist.

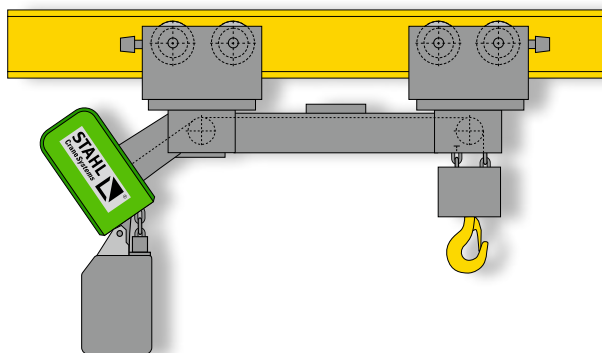

STB Big Bag design

The Big Bag version is designed for load capacities up to 3,200 kg. Its special feature is the free choice of the distance between chain hoist and load hook which makes lifting bulky loads or Big Bags up to top hook position possible without hindering edges such as trolley, chain hoist or chain box.

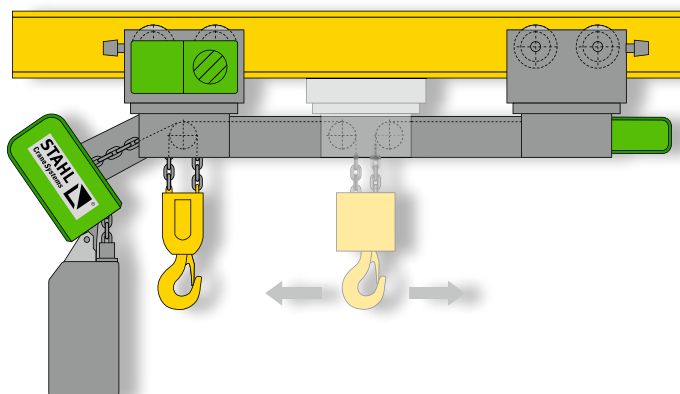

The STD Vario dual chain hoist

The distance between hooks is electrically adjustable and can be individually adapted to loads of different lengths. Both hooks run absolutely in synch. The load hooks cannot be accidentally shifted during lifting or travel.

The technology

It's reassuring to know what convincing technology is concealed in the robust ST chain hoist. The low-maintenance components of the modular chain hoist are optimally matched to each other. They guarantee constant performance, high efficiency and long service life. One of the main features guaranteeing safety in the workplace is the patented solid cast iron chain guide. The load-bearing components are integrated into this component so that the load is supported where it engages. The direct suspension means that the power flux is not diverted via the housing.

1 Chain drive

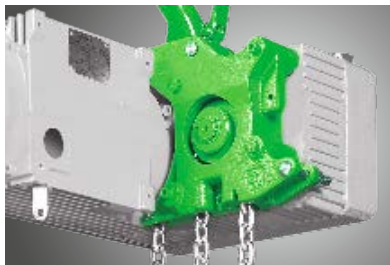

- Innovative patented chain drive
- Anchorage and load-bearing components are directly integrated into the high-tensile grey cast iron
- Simple inspection and replacement of the chain sprocket thanks to over-mounted shaft bearing
- Enclosed chain guide
- Reliable functioning even in demanding applications
- Wear-resistant case-hardened chain sprocket in conjunction with optimised return sheaves; ensuring low wear on the chain

2 Motor

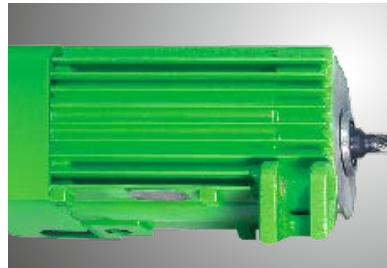

- High standard classification in accordance with ISO (FEM)
- Powerful motors with high duty cycle and number of switching operations
- Standard fan cooling
- Single-speed and four-pole versions are available as options
- Optional temperature control by thermistor

4 Brake

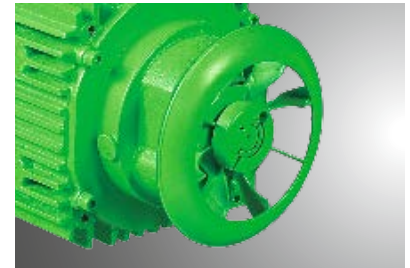

- Low-maintenance, asbestos-free electromagnetic disc brake
- Oversized braking torque
- Long service life, brake pad status can be checked and measured
- Brake completely enclosed, protected from humidity, vapours and dusts from the exterior; ensuring long-term reliable operation

3 Control

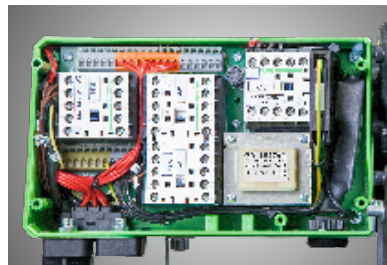

- All customary connecting and control voltages are available
- Plug connection of control pendant and travel motor
- Clear arrangement of contactors
- As an option, available with direct control
- As an option, available without control pendant and/or contactor control

5 Paint



- Standard paint treatment as per RAL 6018 yellow-green and RAL 7021 greyish black
- High-quality primer and top coats for standard applications
- Off-standard paint treatment for outdoor use or corrosive ambient conditions
- Other colours per RAL chart optionally available

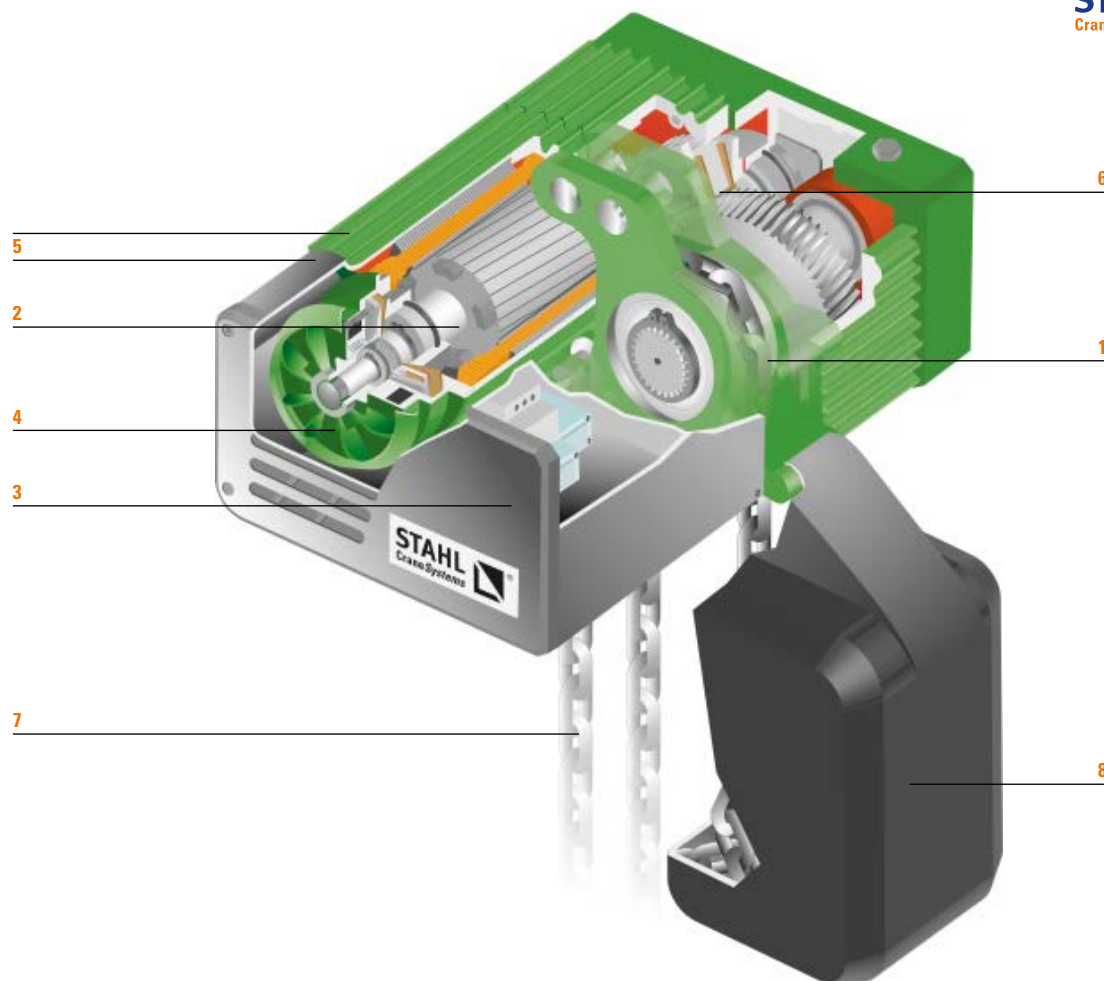

6 Overload slipping clutch and gear



- The slipping clutch of the ST 10 to ST 60 is located in the oil bath.
- Easily adjustable from the exterior
- Precise response
- No electronic limiting necessary
- Various gear reductions available
- Oversized helically geared gearbox

7 Chain

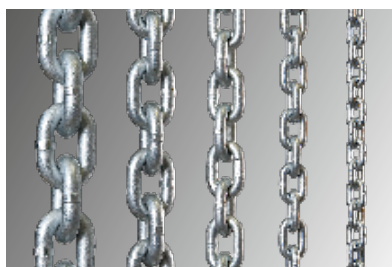

- Surface-hardened, galvanized and large dimensioned load chain
- High case depth for long service life
- High ISO classification
- Stainless steel load chains are available as an option

8 Chain box



- Large selection of chain boxes in plastic, sheet steel or textile
- Available without chain box as an option

The options

There's always room for improvement. Although it is already first-class in standard design, you have the alternative of making your ST chain hoist even safer, even more cost-effective, even more convenient by selecting from numerous mechanical, electrical and electronic options. At the same time you will extend the service life of the chain hoist. You can increase the efficiency of the chain hoist and adapt it to your individual requirements. Here we show you just the most interesting supplementary equipment and options. If you need further detailed information, please contact us directly.

Control pendant



- Robust control pendant with EMERGENCY STOP palm button and control cable
- All switching elements for hoist, cross and long travel are 2-step
- IP 65 protection
- Additional buttons, for example to activate a horn, can easily be fitted.
- Optional load display. All data displayed can be read out on a notebook with the aid of the SMC Multicontroller.

Radio remote control units

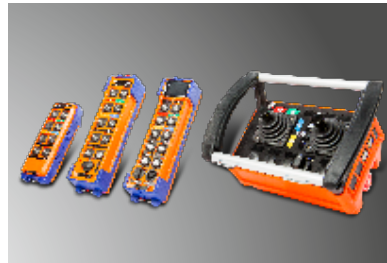

- Pushbutton devices with belt clip, with signal feedback from crane as an option
- Robust plastic casing
- IP 65 protection
- Other radio remote control devices on request.

RMI RadioMOVEit radio remote control



- Ergonomic one-hand pushbutton radio remote control with emergency stop function for all chain hoists
- Suitable for right- and left-handed operators
- Covers the whole load capacity range
- Spiral cable does not restrict the height of lift
- The remote control unit can be positioned anywhere on the chain fall independent of chain size
- Load is guided directly with the non-slip handles

Operational hoist limit switch



- Two versions are possible: cut-off in top hook position or cut-off in top and bottom hook position (stationary, push trolley, electric trolley)
- Activated by the bottom hook block

Gear-type limit switch



- Various functions possible: e.g. routine operational cut-off in highest or lowest hook position or switching from "fast" to "slow" before the stops.
- IP 55 protection, optionally IP 66

SMC Multicontroller



- Continuous load monitoring by overload cut-off even if hoist is at a standstill
- Overload protection with ALC automatic load control
- Load spectrum memory for load-related operating time summation
- Monitoring of motor temperature for hoist and travel motors
- Operating data registration, e.g. operating hours, load spectrum, motor switching operations and load cycles
- Data exchange with PC possible

Travel limit switch



- Travel limit switches on trolley/crab for cross travel, optional
- Limiting for both directions of travel
- Switchover from "fast/slow" (predisconnect)
- Switch contacts designed for control current
- IP 66 protection

Spring-steel chain guide

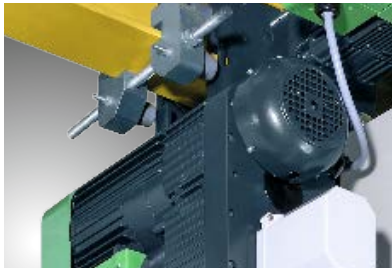

- Heavy high-tensile chain guide for rugged use
- Enclosed chain guide
- Extremely wear-resistant case-hardened chain sprocket

Bypass brake

- Second brake for increased safety
- Identically dimensioned
- Second brake acts in force transmission directly on the load, i.e. bypassed the slipping clutch.

Vibration damper

- Available for STD 10 to STD 60 double chain hoists
- Minimises the vibrations produced by operating the chain hoist and transmitted to the load chain via the chain sprocket (polygon effect)

Load display

- SLD four-digit 7-segment load display (Stahl Load Display), large format, luminous red, available with various interfaces including CAN.
- Choice of 60, 100 or 150 mm digit height
- No additional sensor is required as the standard load sensor is used.

FMD1 slipping clutch test device

- Robust full metal design
- Modern electronic test apparatus with field-proven sensor technology, high degree of accuracy $\pm 2\%$
- Test range up to 4,000 kg on one chain fall, suitable for chains up to 11.3 mm link thickness
- Protector for evaluation device and internal test program
- Simple intuitive handling

		Standard	Options
Ambient temperature		-20 °C to +40 °C	to +80 °C
Protection to IEC/EN 60529		IP 55	IP 66
Paint	Colour	Greyish black/yellow-green RAL 7021/6018	All other colours from RAL colour chart
	D.F.T.	80 µm	120 µm to 240 µm
	Paint	Polyurethane topcoat	Epoxy-resin base (240 µm)
Control pendants		Control pendant with EMERGENCY STOP pushbutton	Radio remote control in pushbutton or joystick version MOVEit one-hand control switch
Control		Contactors control including main contactor	For crane manufacturers, contactor control without transformer and without crane switch contactor Direct control (ST05 – ST20)
Hoist motor control		Pole-changing	Frequency controlled
Travel motor control	50 Hz	20 m/min	2.5/10 m/min and 5/20 m/min
	60 Hz	25 m/min	3.2/12.5 m/min and 6.3/25 m/min pole-changing or frequency controlled
Motor supply voltage	50 Hz/60 Hz	380 – 415 V ST05 also 380 – 400 V or 415 V	All voltages possible
Chain	grade 8 to DIN 5684	Galvanised	Stainless steel chain, off-standard chain (hardened)
	Safety factor	≥ 5,0	–
Chain guide		Grey cast iron EN GJS	Sandwich chain guide made of hardened spring steel plates
Chain box		Plastic	Sheet steel, textile
Load lifting elements		Load hook in bottom hook block	Thread bar VAGH safety load hook Galvanised load hook
Limit switches		–	Operational hoist limit switch Gear-type limit switch
	Travel limit switch	–	For up to four switching functions – pre- and end limiting in both directions of travel, carriage spacing
Overload cut-off		Slipping clutch	Load sensor
	Signal transmitter	–	Horn, flashing light
	Visualisation	–	SLD large-format load display, display in control pendant, readable on PC
	Data exchange	–	with PC
Cumulative load controller		–	SSC
Temperature control of travel motors		–	Ptc thermistors
Mechanical safety devices		–	Wheel arresters
		Guide rollers for wide flange widths dependent on trolley type	Guide rollers for narrow flange widths
		Support rollers for trolleys	–
Hoist brake		Monodisc spring-loaded brake with asbestos-free brake linings	Manual release of hoist brake Bypass brake, double brake
		–	Operating hours counter
Data recording		–	Operating hours counter
Panel box		Plastic (Terluran 969 T)	ST 10 – ST 60 sheet steel (S 235 JR)

The Engineering

Engineering means innovation and individuality. Constantly redefining the lifting and transporting of loads for complex requirements is a job for our experts. Drawing on one of the widest product ranges of standard components, they regularly develop modern, individual off-standard and customised solutions. Hardly any other manufacturer of lifting and crane technology can offer you this diversity of precisely designed top quality customised solutions combined with maximum cost-effectiveness.

The modular ST chain hoist programme forms the basis for the most varied solutions. Compact construction, extremely low headroom, twin chain hoists or multi-reeved chain hoists, STB big bag version, coupled chain hoists for four-point load pick-up. Various trolleys are available for all chain hoists. Customised system solutions individually adapted to your precise requirements are our forte. The experience and knowledge gained from more than 140 years in crane technology gives us the flexibility to develop and produce the optimum solution for your project in short time. On request, all off-standard chain hoists and customised solutions are available in explosion-proof design for Zone 1, Zone 21 and Zone 22.

The facts

- Optimally matched to your project
- Every hoist is the result of over 140 years of experience and expertise
- Short development time
- Cost-effective thanks to modular system
- Technically mature thanks to the use of field-proven standard components
- High quality and reliability ensured by in-house production
- All customised solutions are available as an option in explosion-protected design complying with ATEX and IECEx.



Example 1 ST chain hoist with 30,000 kg load capacity

This off-standard design comprising four ST60 chain hoists from STAHL CraneSystems is designed for the impressive load capacity of 30,000 kg and is used on a maintenance crane in a metallurgy plant in New Caledonia. Loads in this range are normally lifted with wire rope hoists.

Due to the extreme requirements such as restricted space, short approach dimensions, narrow track gauge and true vertical lift a solution with wire rope hoists is not possible. The construction of chain hoists ensures true vertical lift, and they have extremely compact dimensions. This prompted STAHL CraneSystems' engineers to develop an off-standard solution with the robust ST60 chain hoists. The chain hoists are cardanically coupled in pairs ensuring that the hoists run in synch. They were reeved with twice 130 m robust chain with a deadweight of 700 kg. The multi-reeved chains withstand maximum stresses. The chain hoists are disconnected in top and bottom hook position by a gear limit switch. To provide increased safety, the loads are continuously registered by load sensors which disconnect the hoist at overload.

The hoist is mounted on a purpose-built double rail crab with specially developed wheelblocks. With a track gauge of 2,000 mm and a wheelbase of 1,660 mm its dimensions are extremely compact.

The facts

- Combination of four ST60 chain hoists
- 12/4-1 reeving
- Load capacity 30,000 kg
- True vertical lift
- Extremely short approach dimensions
- Track gauge 2,000 mm



Example 2 STD dual chain hoist in series production system

STAHL CraneSystems' engineers designed a cost-effective and reliable overhead monorail system with semi-automatic control for an assembly line. Eight STD dual chain hoists are used on a 93 m closed circular runway to pick up 250 kg components and lift them in synch at two points. The two-point load pick-up ensures that the load is transported safely without swinging.

A buffer store of five trolleys carrying components is ready at the assembly point. Attaching the loads at the loading station is activated manually by radio remote control. Lifting and transport to the buffer store are then automatic. As soon as a new product arrives at the assembly line, the fitter calls for the components by radio remote control. The trolley moves into an unloading station and automatically follows the assembly line at the same speed. The longitudinal position above the line can be corrected by accelerating or braking the drive. Correcting the trolley position at right-angles to the assembly line is possible on a movable skid with a path of 500 mm. Dangerous diagonal pull of the loads is thus prevented.

To increase process reliability, in addition to the radio signal an infrared signal with limited reach is transmitted to the trolleys. Furthermore, a trolley can exit the runway to a maintenance spur via a switch point and be serviced there. The other dual chain hoists are not affected and continue to operate without disturbance.

The facts

- Eight STD chain hoists with monorail trolleys
- Closed circular runway, 93 m long
- Power supply via integrated eight-pole conductor line
- Radio control with redundant infrared signal
- Travel speed synchronised with assembly line
- Chain hoist can be moved at right-angles to the runway on an off-standard skid



Example 3 Four ST chain hoists with a total lifting capacity of 25,000 kg

The boat crane of a Dutch shipyard is equipped with four ST 60 chain hoists from STAHL CraneSystems and designed for a total lifting capacity up to 25,000 kg. Far above the portal crane, there is a further ST chain hoist to upright and stabilise the ship masts.

The crane is used to raise and lower yachts and sailing boats of various sizes from/into the water. The crane and crane controller were modernised to state of the art with the help of extensive technical changes.

The ST 60 chain hoists are suspended freely from hinges so that ships of various widths can be lifted. With suspended load, the hoists are able to tilt into the optimum position. Two of the chain hoists are mounted at a fixed point, and the other two on movable trolleys so that the distances between the hooks can be varied in dependence on the length of the boat. Load sensors, SMC condition monitoring units and an SCC total load controller measure the load at every chain hoist and protect the crane against overloading. An easy-to-read load display shows the total load suspended. The crane is controlled via the radio transmitter. Control is also possible with the control elements in the crane's control box. The four chain hoists can be operated together, individually and in pairs.

The facts

- Portal crane with four ST 60 chain hoists with a lifting capacity of 6,300 kg each, two of which are movable
- Hook spacing can be adjusted to ships of various lengths
- Flexible suspension from hinges for ships of different widths
- Load display
- Load sensors and SSC total load controller
- SMC multi-controller
- Radio remote control



The explosion-protected ST Ex chain hoist



STAHL CraneSystems is known internationally as an explosion protection specialist and is considered one of the world's market leaders in explosion protection technology. The safety of people and machines in areas subject to gas and dust explosion hazards is our top priority. Here we make no compromises. As developer of numerous innovations in this field we have had palpable influence on crane technology. Experience and know-how from many decades, our own fundamental research and development, approvals from the Federal Physico-Technical Institute (PTB) and other test institutes in many countries underline our expertise. Hoisting technology from STAHL CraneSystems ranks among the safest technology on the market in the chemical, petrochemical and pharmaceutical industries, the food processing industry, power supply, shipbuilding, offshore and natural gas liquefaction industries (LNG).

Without exception, the ST Ex chain hoist programme is based on the modular ST chain hoist programme. All components of the explosion-protected chain hoists come from our in-house production, from motor and brake to controls and control pendant. For this ensures the complete, high-quality explosion protection on which users, crane manufacturers and system manufacturers all over the world have relied for decades. The strict ATEX directives and IECEX regulations on mechanical and electrical explosion protection are of course met.

The facts

- International specialist for explosion protection technology
 - One of the most extensive chain hoist ranges for Zone 1, Zone 21 and Zone 22 worldwide
 - Based on the ST chain hoist
 - Design and maintenance to ATEX and IECEX in certified quality
 - All equipment available in explosion-protected design
- For more information, visit www.stahlcranes.com or ask for our brochure "Expertise in explosion protection", which we will gladly send to you by post.

Use	Category	Protection against	Explosion protection class
Zone 1	Ex II 2 G	Gas	Ex de IIB T4 Gb or Ex de IIC T4 Gb
Zone 21	Ex II 2 D	Dust	Ex tb IIIC T 120°C Db
Zone 22	Ex II 3 D	Dust	Ex tc IIIC T 120°C Dc

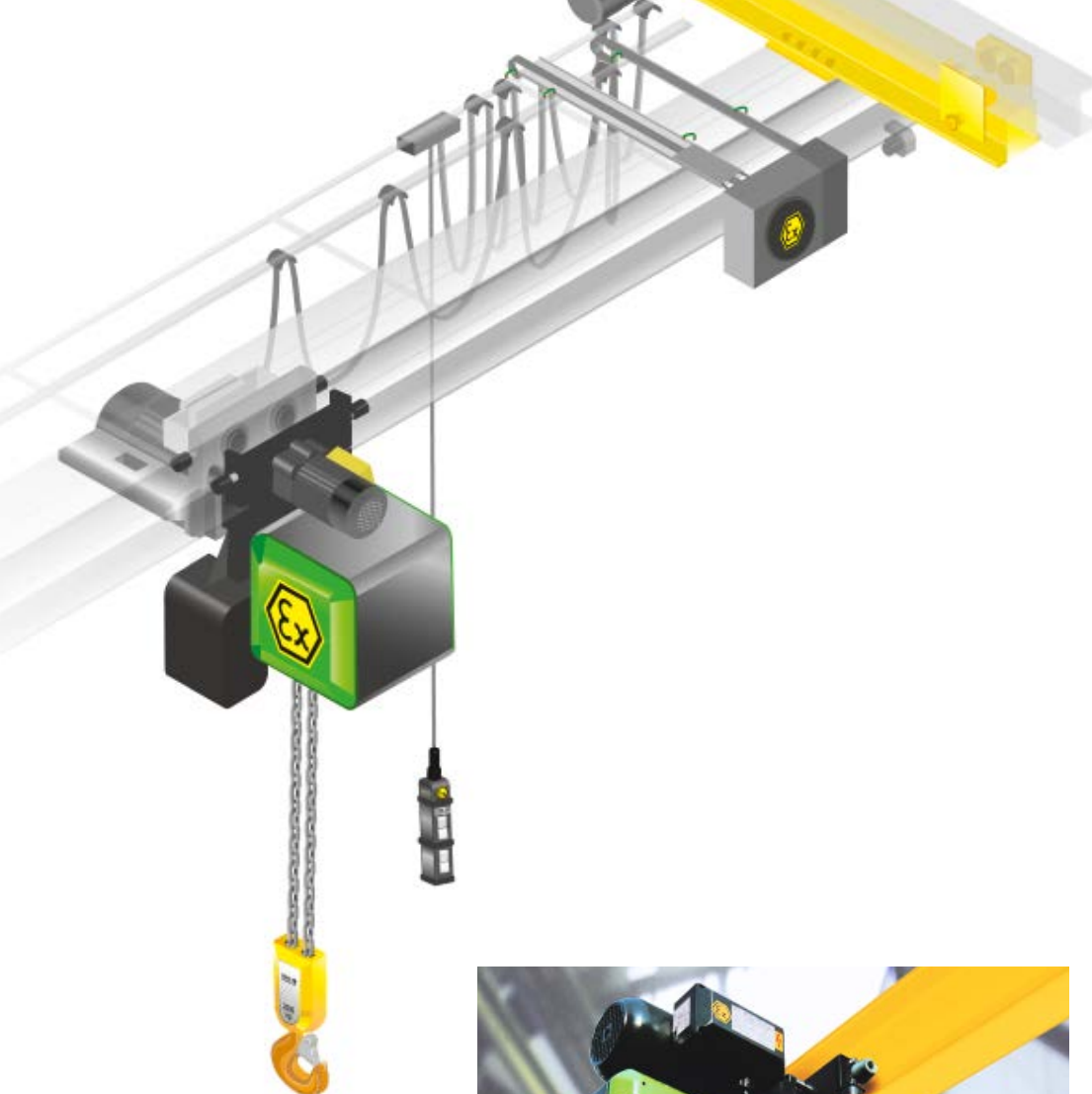

The ST Ex chain hoist for Zone 22 is available in six frame sizes up to a load capacity of 6,300 kg.



The ST Ex chain hoist for Zone 1 and Zone 21 is available in two frame sizes up to a load capacity of 5,000 kg.



The support

Quality right down to the most minor detail is the standard STAHL CraneSystems is committed to. Not only in the field of crane technology, but also on the subject of support. You will find lifting and crane technology from STAHL CraneSystems all around the world. Developed by engineers and experts, manufactured with maximum care following our well-known standard of quality. All around the world, many companies from various fields have decided on maximum safety and quality, on products from STAHL CraneSystems.

When it comes to sales, we are committed exclusively to capable, professional crane manufacturing partners. From them you can expect optimum support when it comes to your individual crane system with hoisting and crane technology from STAHL CraneSystems. Consulting and erection of a new system, system-oriented testing and maintenance, modernisation, spare parts supply and training courses. Together with our subsidiaries and crane manufacturing partners we offer you perfectly coordinated support all over the world.





Spare parts – accessible right around the clock

Our own subsidiaries and numerous partners around the world ensure reliable spare parts supply and expert assistance in your area. Even decades after a series has been discontinued, spare parts are available all over the world right around the clock.



Training courses

We constantly keep our regional crane manufacturing partners up to date with training courses, seminars and information material. You too can profit directly from our expertise. We impart practical and theoretical knowledge in our own training centre or on your premises. The seminars on offer in the form of individual, basic and advanced courses cover all main product groups. However we would also be pleased to match a special programme to your individual specifications and requirements.

You will find our current seminar programme at www.stahlcranes.com/en/support



Factory service centre – in action all over the world

Our factory service centre is a service for our customers: wherever you are we assist your crane or systems manufacturer with our experience and expertise whenever he needs us. Up-to-date diagnostic apparatus and condition monitoring systems stand by to support professional service and maintenance work. Not only you, but your system, are in safe hands. You can rely on us.

Your will find our online service at mplus.stahlcranes.com and you can reach our factory service centre on customer.service@stahlcranes.com



The ST chain hoist in action

Experts in all countries immediately recognise hoists and crane components from STAHL CraneSystems. For the ST chain hoist is in action all around the world in the most diverse variants and solutions. Innovative, thought through down to the most minor detail and manufactured with greatest care, the ST chain hoist continues to conquer new areas of application. It thus proves its well above average flexibility and cost-effectiveness. STAHL CraneSystems is represented on all continents by subsidiaries, sales and crane manufacturing partners.





4

1 An ST 20 explosion-protected chain hoist with a load capacity of 1,600 kg is used for outdoor maintenance work in a chemical plant. The narrow construction of the explosion-protected chain hoist enables the whole width of the crane bridge to be used. The travel drives of the underhung crane endcarriages are also in explosion-protected design.



5

- 2 Chain hoists of various models are used with single girder suspension cranes in a sawmill in the Netherlands.
- 3 Only 210 mm high: The extra short headroom trolley makes optimum use of the hook path in the low hall of a plastic casting factory in combination with the ST 50 chain hoist for a load capacity of up to 5,000 kg. The headroom reduced by over 60 % simultaneously increases the height of lift.
- 4 Two STD dual chain hoists with the aid of four synchronously operating load hooks enable long goods weighing 10 tonnes to be transported without swinging.
- 5 Two STD dual chain hoists ensure safe handling of heavy paper reels in Büttenpapierfabrik Gmund. The STD dual chain hoist is also suitable for low-ceilinged rooms thanks to its low headroom.
- 6 48 off-standard chain hoists operate in extremely high humidity in a coating plant for the motor industry in China.



6



1



3



2



4



5



7



6

- 1 A special crane with height-reduced endcarriages and an individually adapted STD 50 double chain hoist works in a burnishing line.
- 2 A light crane system with ST 05 chain hoists provides assistance in the repair, maintenance and servicing of racing cars.
- 3 The single-fall design of the ST 50 chain hoist permits fast hoisting speeds for load capacities up to 2,500 kg. It is mounted with a push trolley on a wall slewing crane.
- 4 Big Bag beams are lifted up to top hook position without any hindering edges with the Big Bag design for load capacities up to 3,200 kg.
- 5 Two ST 50 chain hoists acting in tandem lift complete car bodies and transport them along the assembly line.
- 6 A number of ST chain hoists are used in the maintenance and replacement of train rails in England. All the hoists are equipped with customised load lifting equipment. They are centrally controlled to ensure that they work in synch. They are disconnected by a gear limit switch, reliably limiting the lifting process.
- 7 A chain hoist in short headroom trolley version is mounted on a single girder overhead travelling crane. It is used for transporting fork-lift truck batteries to the charging station.



You can find this and other brochures at www.stahlcranes.com/download. We will gladly also send them to you by post.

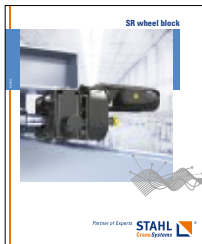
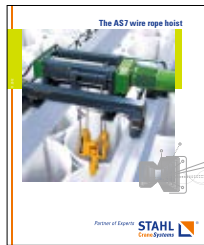

Presented by

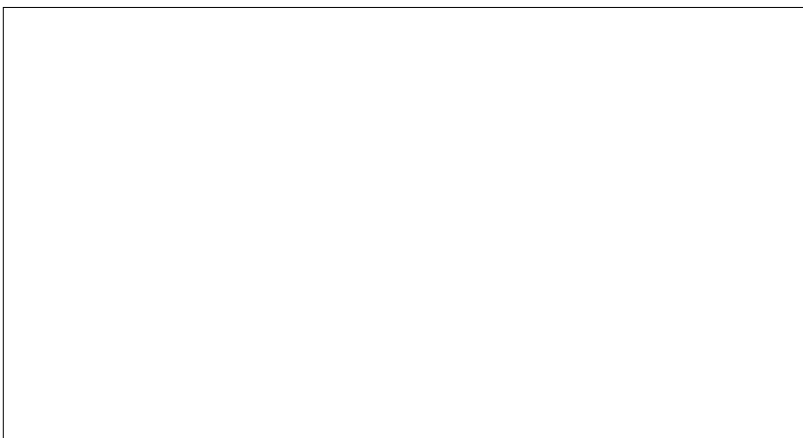

→ www.stahlcranes.com

STAHL CraneSystems GmbH
Daimlerstr. 6, 74653 Künzelsau, Germany
Tel +49 7940 128-0, Fax +49 7940 55665
marketing.scs@stahlcranes.com

Partner of Experts



All specifications and illustrations are non-binding.
Subject to modification, errors and printing errors excepted.
Printed in Germany 990 040 0 EN-09.17 visuell.de